



PARTS DRAWING



EH110MK3
110 Volt
Halogen Infra-Red Heater

Serial Number Range:

Year Of Manufacture:



KEEP THIS BOOKLET FOR FUTURE REFERENCE



Nottingham: 0115 946 1988

London: 0208 830 3333



Nottingham: sales@hscgroupuk.co.uk

London: sean@hscgroupuk.co.uk

www.hscgroupuk.co.uk
The Hire Supply Company (UK) Limited



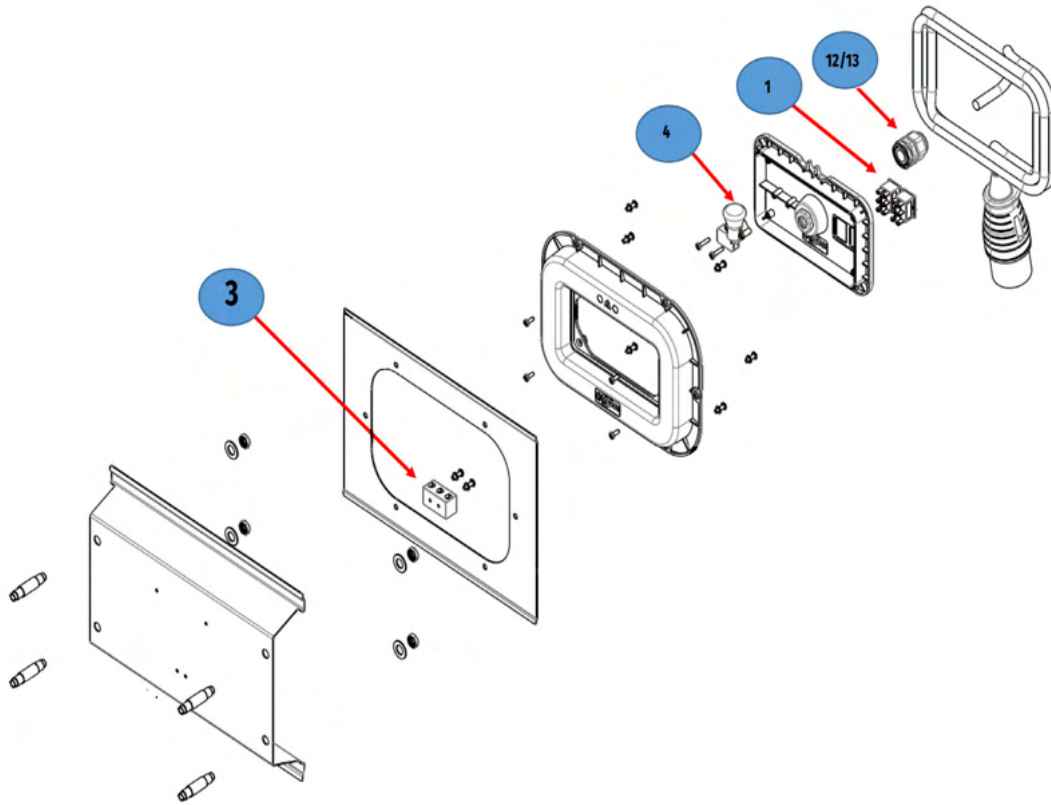

Item No	Code	Name
1	EHMK3001	ELITE HEAT MARK 3 ON/OFF ROCKER SWITCH EHMK3001
2	EHMK3002	ELITE HEAT MARK 3 125MM WHEEL EHMK3002
3	EHMK3003	ELITE HEAT MARK 3 4-WAY LAMP TERMINAL BLOCK EHMK003
4	EHMK3004	ELITE HEAT MARK 3 DUAL VOLTAGE TILT SWITCH EHNK3004
5	EHMK3005	ELITE HEAT MARK 3 FRONT SAFETY GRILL EHMK3005
6	EHMK3006	ELITE HEAT MARK 3 CREAMIC LAMP END CAPS EHMK3006
7	EHMK3007	ELITE HEAT MARK 3 110V 1200W IR HEATING ELEMENT EHMK3007
8	EHMK3008	ELITE HEAT MARK 3 240V 1200W IR HEATING ELEMENT EHMK3008
9	EHMK3009	ELITE HEAT MARK 3 COMPLETE HEATER CASSETTE 110V EHMK3009
10	EHMK3010	ELITE HEAT MARK 3 COMPLETE HEATER CASSETTE 240V EHMK3010
11	EHMK3011	ELITE HEAT MARK 3 WHEEL AXLE ASSEMBLY EHMK3011
12	EHMK3012	ELITE HEAT MARK 3 M20 CABLE GLAND FOR 110V HEATER EHMK3012
13	EHMK3013	ELITE HEAT MARK 3 M16 CABLE GLAND FOR 240V HEATER EHMK3012
14	EHMK3014	ELITE HEAT MARK 3 VENTED HEATER GRILL EHMK3014
15	EHMK3015	ELITE HEAT MARK 3 HEATER LAMP CLIPS EHMK3015
16	EHMK3016	ELITE HEAT MARK 3 BASE FIXING BOLT AND WASHER (3) EHMK3016
34	EHMK3034	ELITE HEAT MARK 3 MAIN BODY EHMK3034
35	EHMK3BA	ELITE HEAT MARK 3 WHEEL BASE ASSEMBLY EHMK3BA

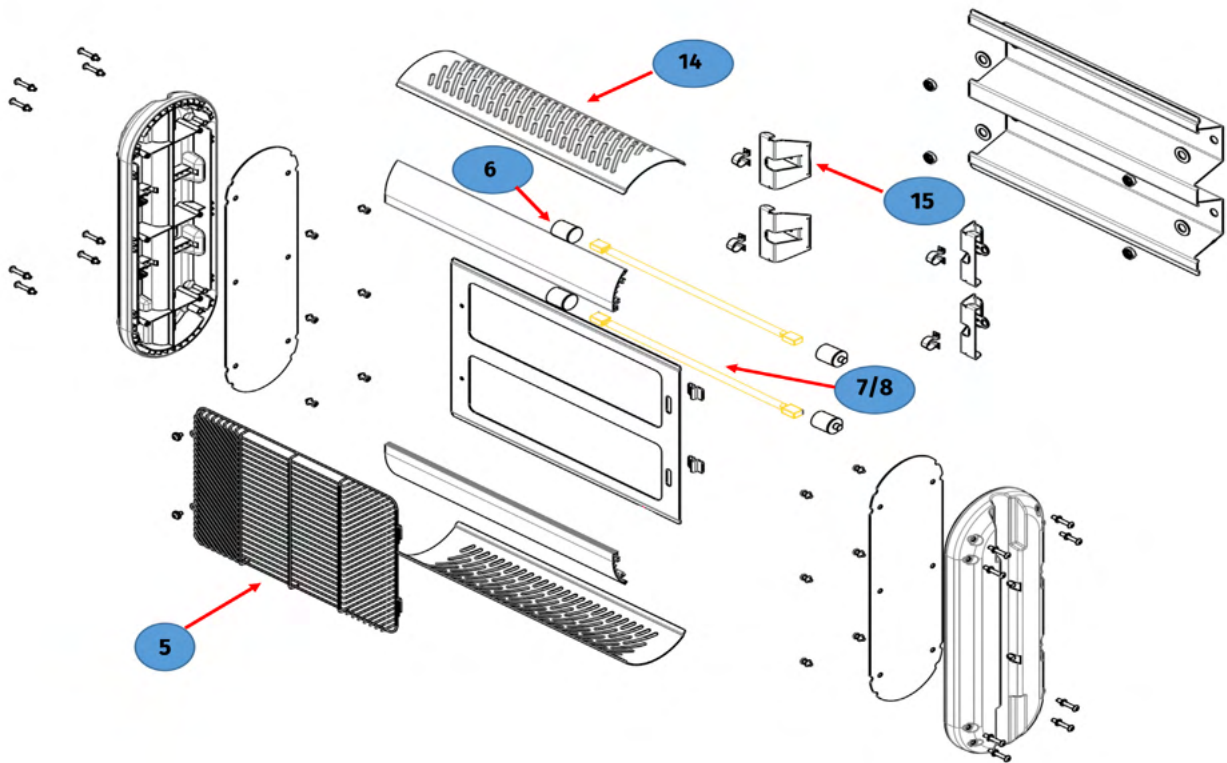

Item No	Code	Name
1	EHMK3001	ELITE HEAT MARK 3 ON/OFF ROCKER SWITCH EHMK3001
2	EHMK3002	ELITE HEAT MARK 3 125MM WHEEL EHMK3002
3	EHMK3003	ELITE HEAT MARK 3 4-WAY LAMP TERMINAL BLOCK EHMK003
4	EHMK3004	ELITE HEAT MARK 3 DUAL VOLTAGE TILT SWITCH EHNK3004
5	EHMK3005	ELITE HEAT MARK 3 FRONT SAFETY GRILL EHMK3005
6	EHMK3006	ELITE HEAT MARK 3 CREAMIC LAMP END CAPS EHMK3006
7	EHMK3007	ELITE HEAT MARK 3 110V 1200W IR HEATING ELEMENT EHMK3007
8	EHMK3008	ELITE HEAT MARK 3 240V 1200W IR HEATING ELEMENT EHMK3008
9	EHMK3009	ELITE HEAT MARK 3 COMPLETE HEATER CASSETTE 110V EHMK3009
10	EHMK3010	ELITE HEAT MARK 3 COMPLETE HEATER CASSETTE 240V EHMK3010
11	EHMK3011	ELITE HEAT MARK 3 WHEEL AXLE ASSEMBLY EHMK3011
12	EHMK3012	ELITE HEAT MARK 3 M20 CABLE GLAND FOR 110V HEATER EHMK3012
13	EHMK3013	ELITE HEAT MARK 3 M16 CABLE GLAND FOR 240V HEATER EHMK3012
14	EHMK3014	ELITE HEAT MARK 3 VENTED HEATER GRILL EHMK3014
15	EHMK3015	ELITE HEAT MARK 3 HEATER LAMP CLIPS EHMK3015
16	EHMK3016	ELITE HEAT MARK 3 BASE FIXING BOLT AND WASHER (3) EHMK3016
34	EHMK3034	ELITE HEAT MARK 3 MAIN BODY EHMK3034
35	EHMK3BA	ELITE HEAT MARK 3 WHEEL BASE ASSEMBLY EHMK3BA

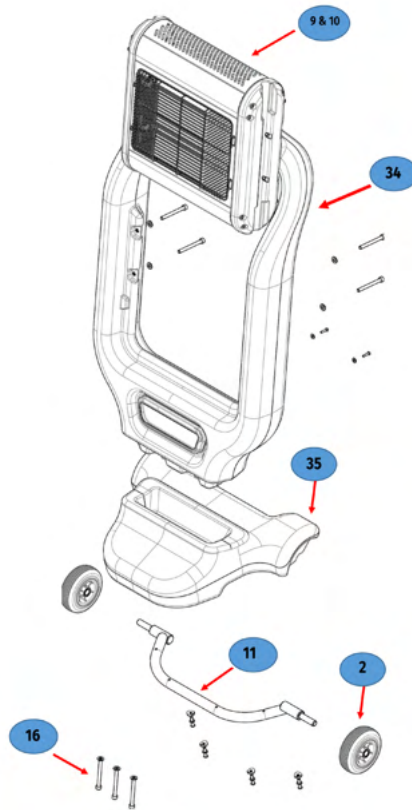

Item No	Code	Name
1	EHMK3001	ELITE HEAT MARK 3 ON/OFF ROCKER SWITCH EHMK3001
2	EHMK3002	ELITE HEAT MARK 3 125MM WHEEL EHMK3002
3	EHMK3003	ELITE HEAT MARK 3 4-WAY LAMP TERMINAL BLOCK EHMK003
4	EHMK3004	ELITE HEAT MARK 3 DUAL VOLTAGE TILT SWITCH EHNK3004
5	EHMK3005	ELITE HEAT MARK 3 FRONT SAFETY GRILL EHMK3005
6	EHMK3006	ELITE HEAT MARK 3 CREAMIC LAMP END CAPS EHMK3006
7	EHMK3007	ELITE HEAT MARK 3 110V 1200W IR HEATING ELEMENT EHMK3007
8	EHMK3008	ELITE HEAT MARK 3 240V 1200W IR HEATING ELEMENT EHMK3008
9	EHMK3009	ELITE HEAT MARK 3 COMPLETE HEATER CASSETTE 110V EHMK3009
10	EHMK3010	ELITE HEAT MARK 3 COMPLETE HEATER CASSETTE 240V EHMK3010
11	EHMK3011	ELITE HEAT MARK 3 WHEEL AXLE ASSEMBLY EHMK3011
12	EHMK3012	ELITE HEAT MARK 3 M20 CABLE GLAND FOR 110V HEATER EHMK3012
13	EHMK3013	ELITE HEAT MARK 3 M16 CABLE GLAND FOR 240V HEATER EHMK3012
14	EHMK3014	ELITE HEAT MARK 3 VENTED HEATER GRILL EHMK3014
15	EHMK3015	ELITE HEAT MARK 3 HEATER LAMP CLIPS EHMK3015
16	EHMK3016	ELITE HEAT MARK 3 BASE FIXING BOLT AND WASHER (3) EHMK3016
34	EHMK3034	ELITE HEAT MARK 3 MAIN BODY EHMK3034
35	EHMK3BA	ELITE HEAT MARK 3 WHEEL BASE ASSEMBLY EHMK3BA



Recycling



ENVIRONMENTAL PROTECTION: Please recycle any unwanted materials as opposed to disposing them as general waste. It is recommended the original is retained and used to store the product when not in use for prolonged periods of time. If this is not applicable ensure the materials are sorted and recycled in accordance with local regulations.



SPECIFICATION CHANGE: It is our policy to continually improve products to ensure these meet the rigours of the industry we serve. Therefore, as such we reserve the right to alter specifications, data and components parts without prior notice.

WARRANTY: Please refer to the manufacturer's terms & conditions

IMPORTANT: No liability will be accepted for the incorrect use of this product.

